

DOOR MIRROR COVERS

*CIVIC*

### GENERAL VIEW

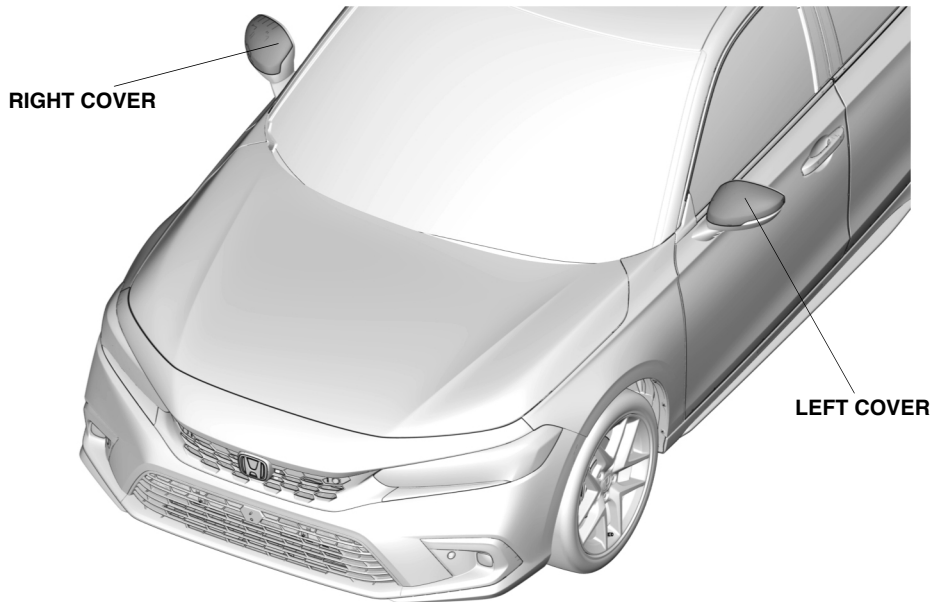

QL00601AU

### FOR YOUR SAFETY (Read carefully)

#### Introduction of Symbol Messages

- These symbols warn you about the possible hazards and explain how to avoid them. The symbols also provide you with some advice.

**⚠ DANGER**

You will be killed or seriously hurt if you do not follow the instructions.

**⚠ WARNING**

You may be killed or seriously hurt if you do not follow the instructions.

**⚠ CAUTION**

You may be hurt if you do not follow the instructions.

**NOTICE**

Gives advice to prevent damage to the product.  
Gives helpful information or instructions to be followed in using the product.



Indicates prohibited actions.

## Introduction of Icons

- These icons indicate the working place and the worker's viewing angle.

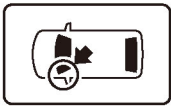

The place for the vehicle.

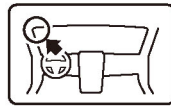

The place for the instrument panel.

- These icons indicate the necessary actions that need to be taken to ensure your safety and the success of the work.



Wear eye protection.



Wear heavy gloves.



Work with an assistant.



Place the part on a blanket.



Remove any burrs.



Use the touch-up paint and dry.



Keep the parts and give them to the customer. (Do not use)



Press firmly.



Tighten by the specified torque.



Work perpendicularly.



Clean with the contact cleaner.

## Wire Harness Routing Precaution

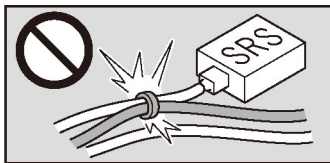

Do not clamp the accessory harness and SRS harness together.

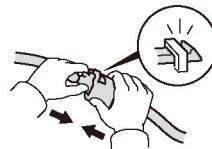

Connect the connectors and terminals securely until they lock.

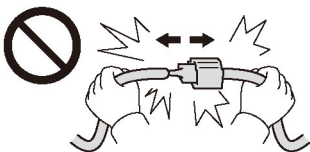

Do not pull the harness to disconnect the connectors.

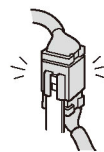

Reinstall the connectors to their original positions if they were removed.

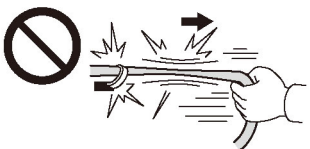

Do not pull the harness strongly.



Secure the accessory harness to the specified position so that the accessory harness does not hang down.



Do not pinch the harness with the parts.

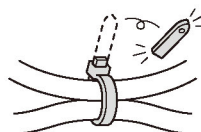

Cut off the excess from the wire ties.

## Safety: General

- Follow all safety information and precautions described in the workshop manual in addition to those described in these installation instructions. Most importantly, take extreme care to ensure your own safety and the safety of others.
- Be careful not to damage the vehicle and the parts.
- Be extremely careful when you handle the retaining tabs and clips.
- Note the locations of the parts before removing them so that they can be reinstalled in their original positions properly.
- The illustrations may differ a little from the actual accessories for the design change of the vehicle.

## Safety: For Electric Parts

- Do not install the accessories if the negative cable of the battery is connected.

## PARTS LIST

### Door Mirror Cover Kit



## TOOLS AND SUPPLIES REQUIRED

- Flat-tip screwdriver
- Ratchet
- Handy remover
- Tape
- 10mm socket
- Grease
- Shop towel
- 10mm open end wrench
- Masking tape

# INSTALLATION

## Disconnecting the Battery Cable

1. Perform the work before you disconnect the negative cable from the battery as shown below.
2. Make sure that you have the anti-theft code for the audio/navigation system. Record some settings of the vehicle if necessary.
3. Disconnect the negative cable from the battery.

### NOTICE

- For hybrid vehicles, ensure that the negative cable is not disconnected from the battery for three minutes after turning the power switch to OFF.

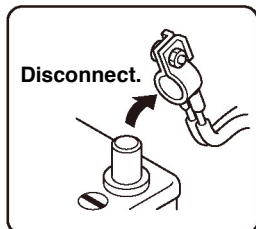
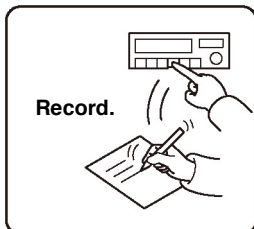
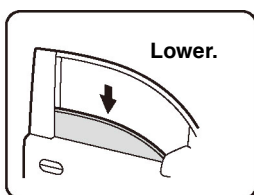

QCD0502BM

## Removing the Vehicle Parts

4. Attach the tape to protect the vehicle.

### NOTICE

- Do not remove the tape until after the reinstallation.

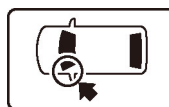

<OPPOSITE SIDE VIEW>

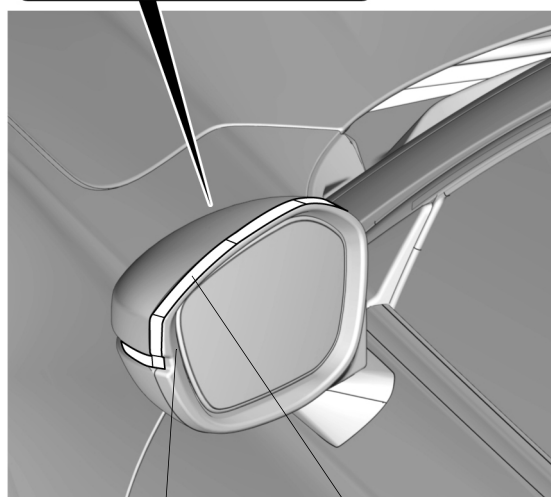
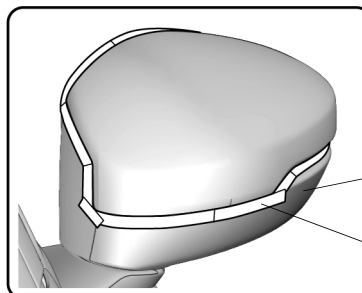

QL21701AU

5. Release the left mirror holder.

**NOTICE**

- Be careful not to damage the retaining tabs.

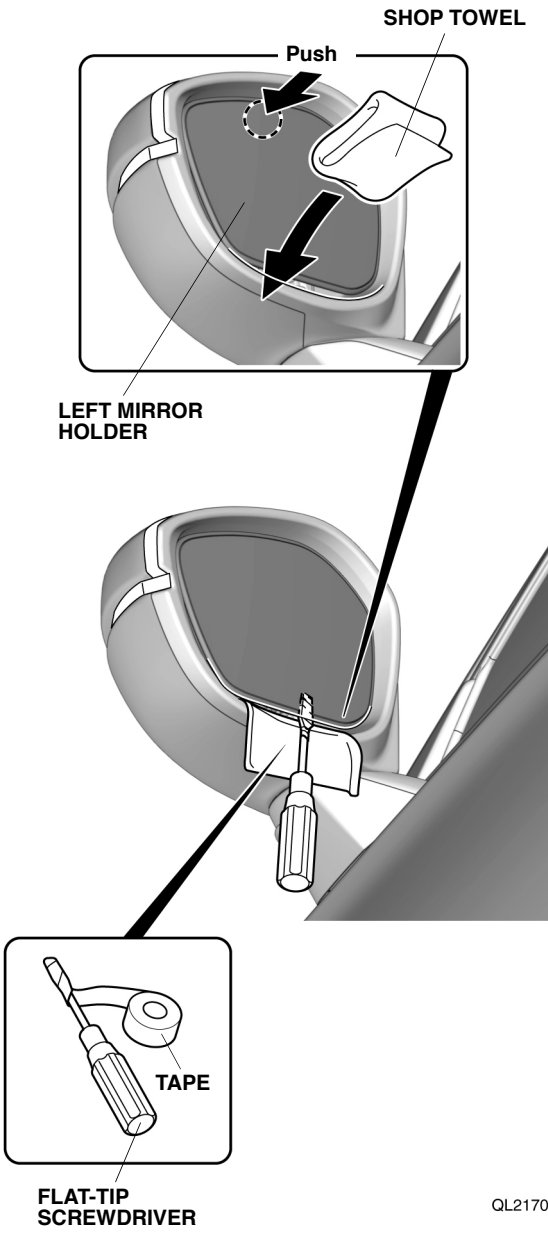

6. Attach the masking tape to prevent incorrect vehicle connector.

7. Remove the left mirror holder.

**NOTICE**

- Make sure that there are no cracks or deformations on the mirror holder.

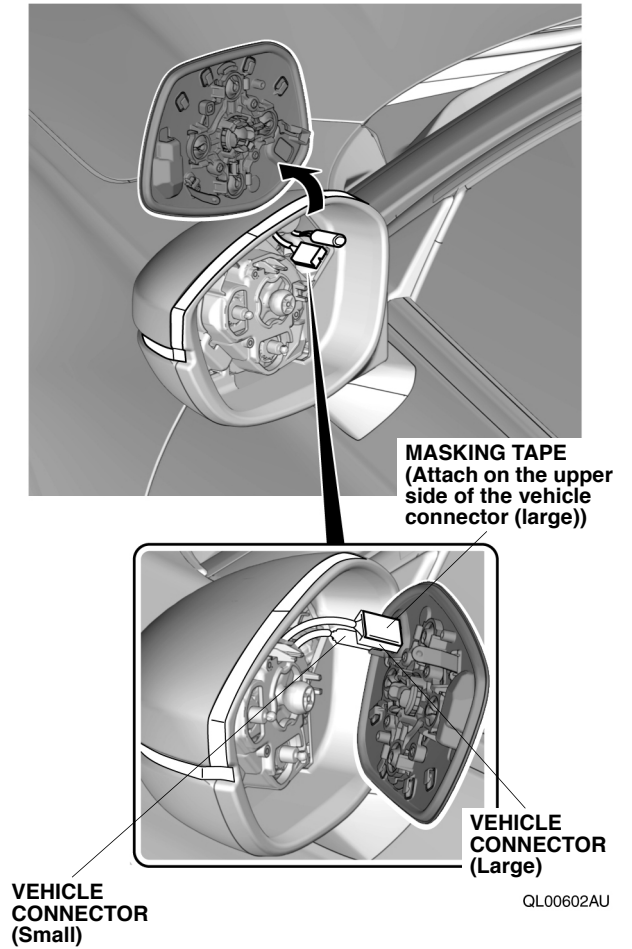

8. Remove the left skull cap.

**NOTICE**

- Be careful not to damage the retaining tabs.
- Remove in the order shown.

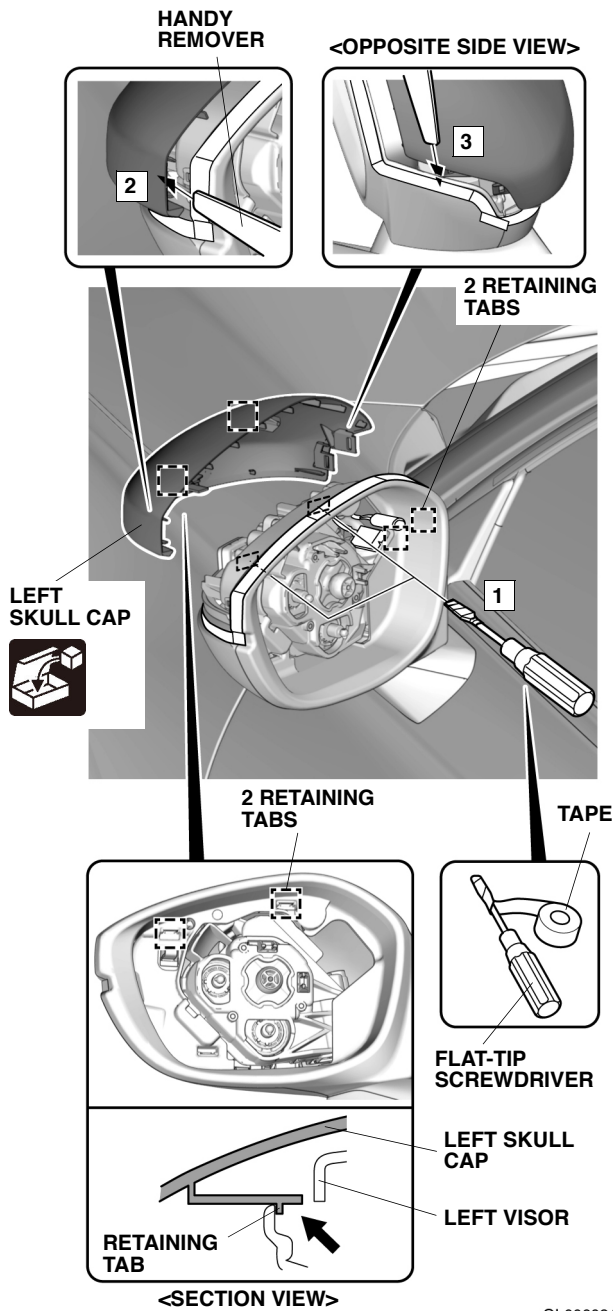

QL00603AU

**Installing the Covers**

9. Install the left cover.

**NOTICE**

- Make sure that there is no gap between the cover and the visor.
- Make sure to secure the retaining tabs properly.

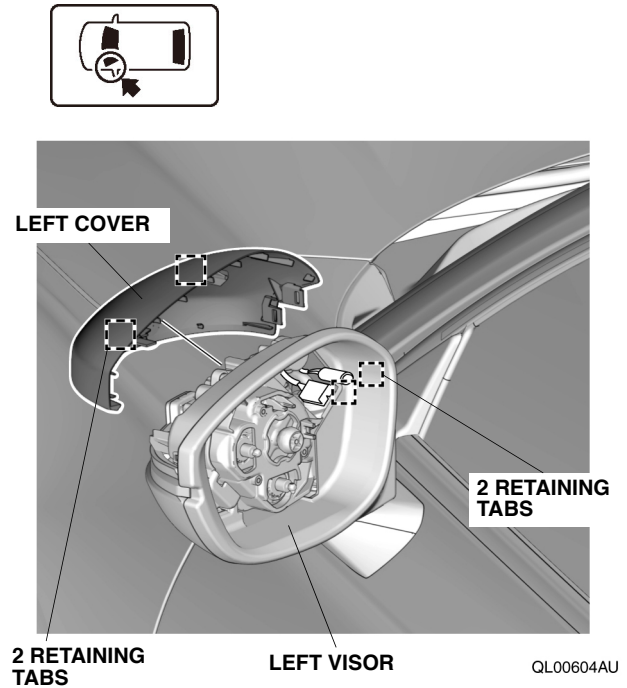

QL00604AU

10. Reconnect the vehicle connectors and remove the masking tape.

**NOTICE**

- Make sure to install vehicle connectors in the correct orientation.

11. Reinstall the left mirror holder.

**NOTICE**

- Apply the grease as described in the workshop manual.
- Install in the order shown.

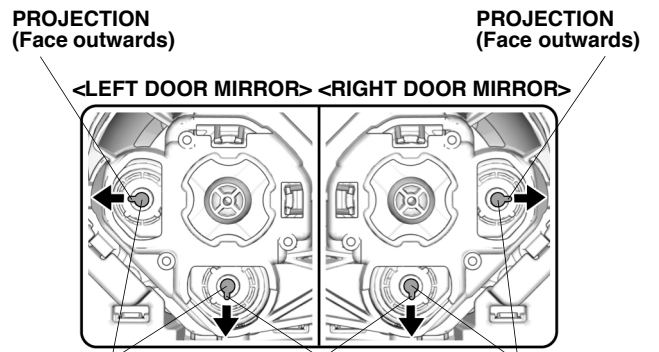

2 ACTUATOR RODS PROJECTIONS (Face downwards) 2 ACTUATOR RODS

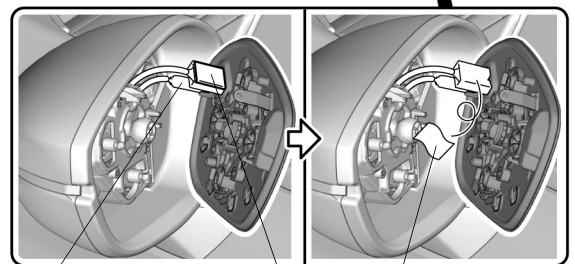
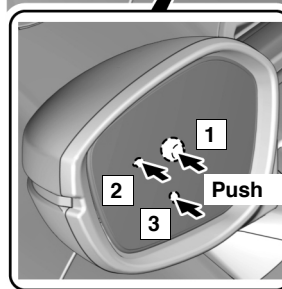
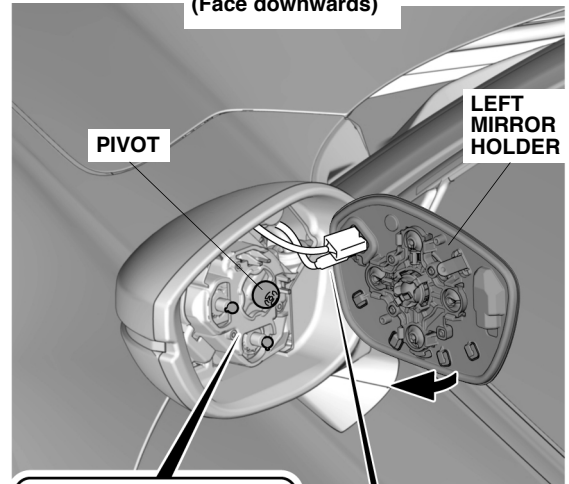

VEHICLE CONNECTOR (Small)

VEHICLE CONNECTOR (Large)

MASKING TAPE

QL00605AU

12. Check the left mirror holder.

### NOTICE

- Move the mirror holder in all directions to ensure that it is installed securely.

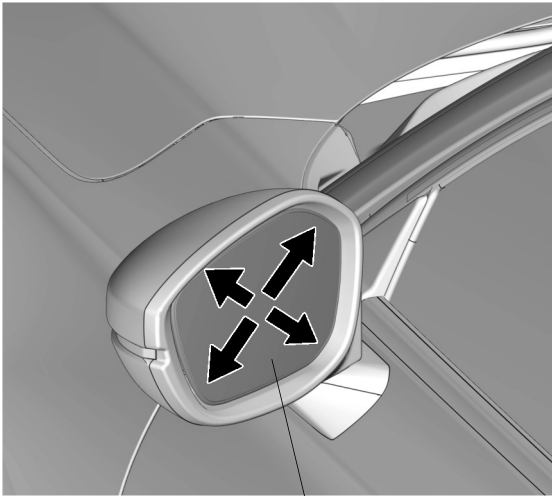

LEFT MIRROR HOLDER QK70307AR

13. Repeat the same procedures on the other side.

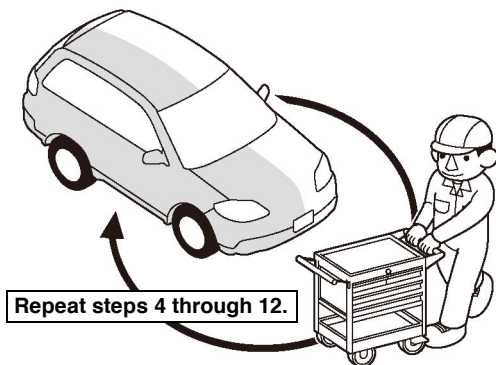

Q9D1014AM

## Check After Installation

14. Check that all parts are routed and installed properly.

### NOTICE

- Check that the harnesses are not pushed, not pulled and not pinched.
- Check that all clamps and wire ties are installed securely.

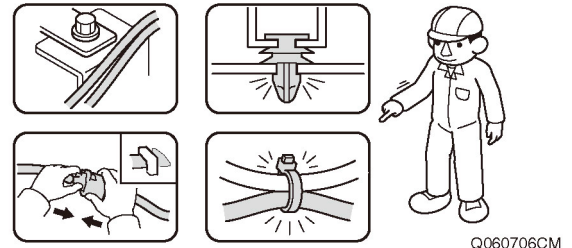

Q060706CM

## Operation Check

15. Reconnect the negative cable to the battery.

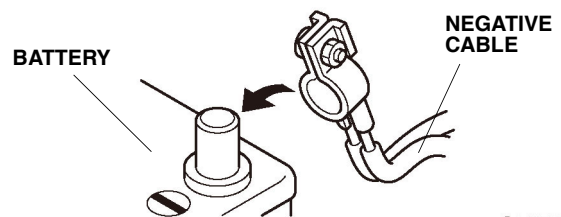

Q060702BM

16. Check that the turn signal, angle adjustment and movement of the mirror operate properly.

## Vehicle Check

17. Check that the electric accessories and systems operate properly.
18. Press and hold the audio power button for two seconds, or enter the anti-theft code for the audio/navigation system.
19. Reset the memory of each piece of equipment and restore the positions of the control knobs.

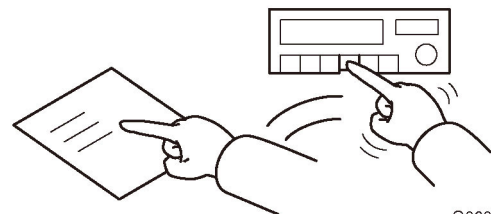

Q060704BM