

SIDE OUT PANEL COVERS	<i>e:Ny1</i>
-----------------------	--------------

GENERAL VIEW

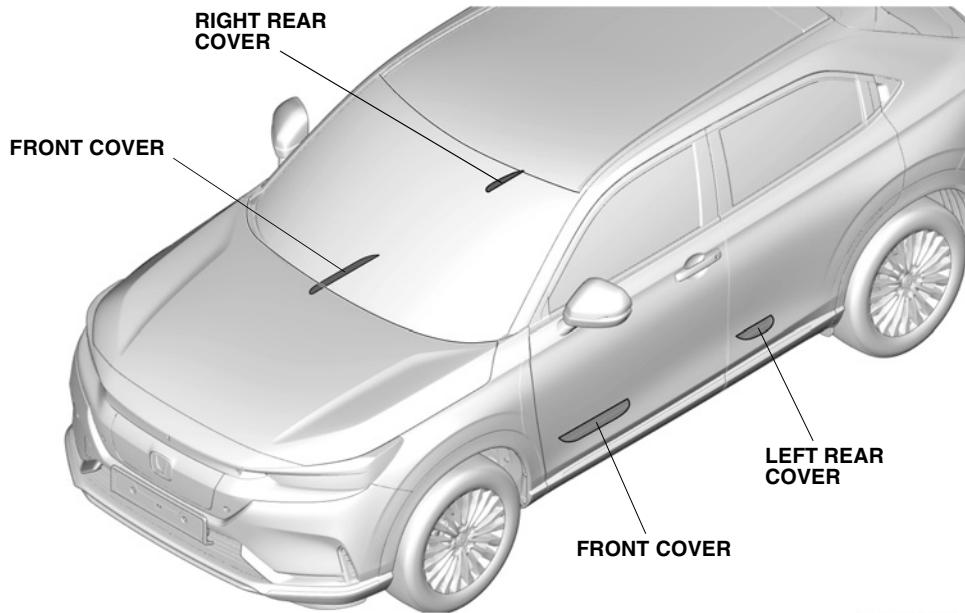

QM50201AK

FOR YOUR SAFETY (Read carefully)

Introduction of Symbol Messages

- These symbols warn you about the possible hazards and explain how to avoid them. And give you some advices.

⚠ DANGER

You will be killed or seriously hurt if you do not follow the instructions.

⚠ WARNING

You can be killed or seriously hurt if you do not follow the instructions.

⚠ CAUTION

You can be hurt if you do not follow the instructions.

NOTICE

Gives advice to prevent damage to the product.
Gives helpful information or instructions to be followed in using the product.



Indicates prohibited actions.

Introduction of Icons

- These icons indicate the working place and the worker's vision.

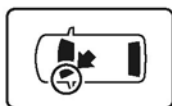

The place for the vehicle.

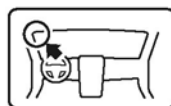

The place for the instrument panel.

- These icons indicate the necessary things for your safety and the work.



Wear eye protection.



Wear heavy gloves.



Work with an assistant.



Place the part on a blanket.



Remove any burrs.



Use the touch-up paint and dry.



Keep the parts and give it to the customer.
(Not use)



Press firmly.



Tighten by specified torque.



Work perpendicularly.



Clean with the contact cleaner.

Safety: General

- Be careful not to damage the vehicle and the parts.
- The illustrations may differ a little from the actual accessories for the design change of the vehicle.

Safety: For the Accessory

- **Do not perform installation work and attaching work at the place where gets the direct rays of the sun or the dust appears.**
- **Always install these accessories at the ambient air temperature 15°C (60°F) or above.**
- **Heat the accessories and bonding surfaces if the ambient air temperature is below 15°C (60°F).**
- **Attach the accessories by pressing it firmly with the palm of your hand. Be careful not to damage the accessories and the vehicle parts.**
- **Carefully place the double-sided adhesive tape on the proper position. Once the double-sided adhesive tape touches the surface, do not try to detach and relocate it. If you attempt to move after it touches the surface, you will damage the part before the adhesive will give way.**
- **Not to wash the vehicle for 24 hours to allow the adhesive to cure.**

PARTS LIST

Side Out Panel Covers Kit

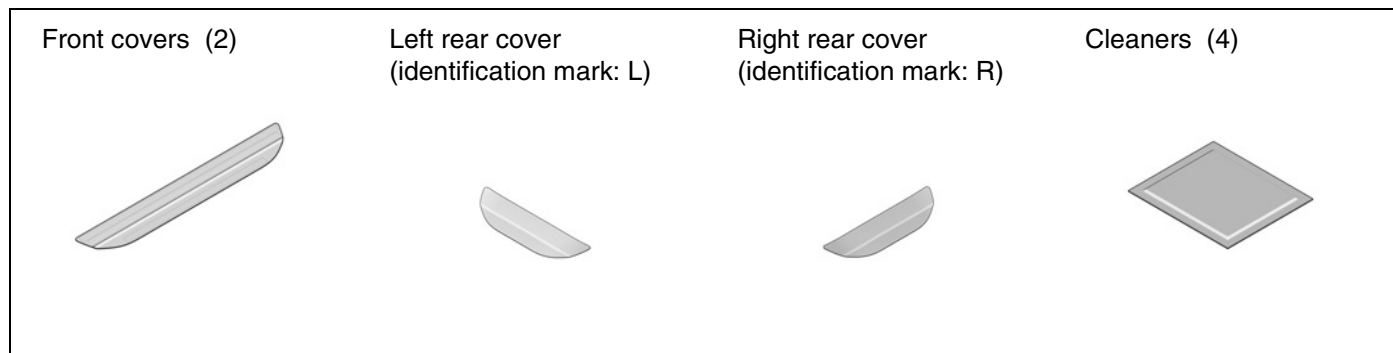

TOOLS AND SUPPLIES REQUIRED

- Masking tape
- Ruler

INSTALLATION

Installing the Covers

1. Attach the masking tape.
2. Clean the vehicle panel.

NOTICE

- Allow to dry thoroughly.



EDGE OF LEFT FRONT DOOR SILL TRIM

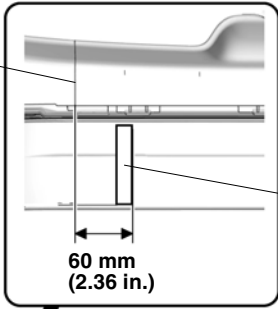

MASKING TAPE

DOOR OPENING SEAL

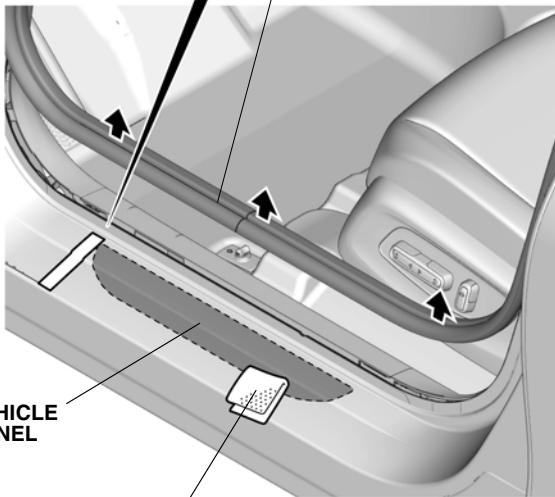

VEHICLE PANEL

CLEANER

QM50202AK

3. Temporarily attach the adhesive backings.

3 ADHESIVE BACKINGS

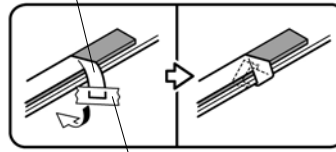

MASKING TAPES

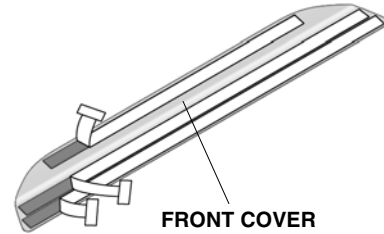

FRONT COVER

QM50203AK

4. Align the front cover.

<SECTION VIEW>

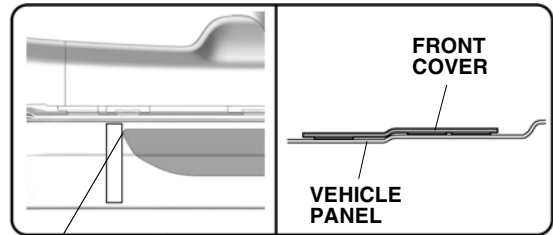

Align.



QM50204AK

5. Secure the front cover.

NOTICE

- Install in the order shown.
- Check the position of the double-sided adhesive tapes and make sure to press firmly.

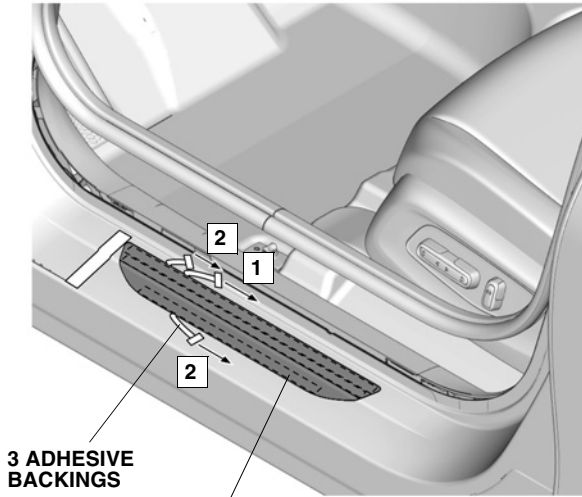

QM50205AK



6. Remove the masking tape.
7. Reinstall the door opening seal.

8. Attach the masking tapes.
9. Clean the vehicle panel.

NOTICE

- Allow to dry thoroughly.

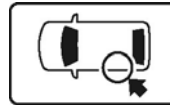

EDGE OF LEFT REAR DOOR SILL TRIM

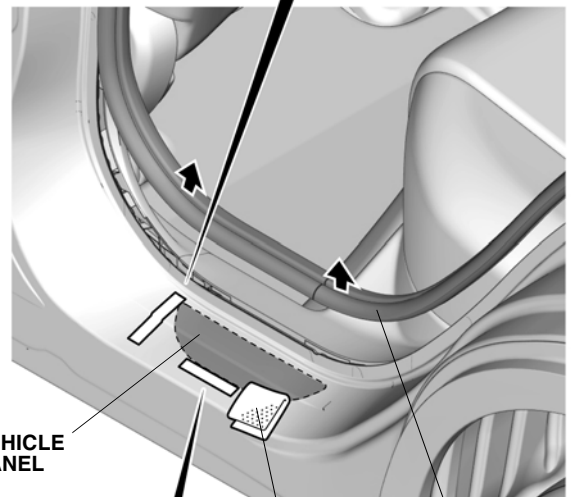
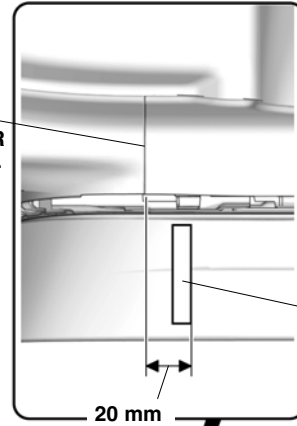

MASKING TAPE

CLEANER

DOOR OPENING SEAL

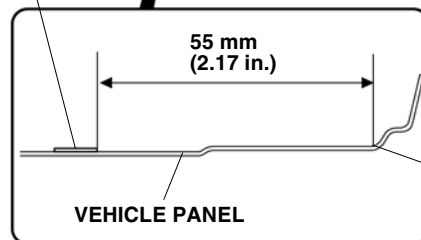

<SECTION VIEW>

QM50206AK

10. Temporarily attach the adhesive backings.

NOTICE

- Check the identification mark and the installation position of the cover.

3 ADHESIVE BACKINGS

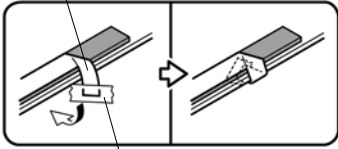

LEFT REAR COVER
(identification mark: L)

MASKING TAPES

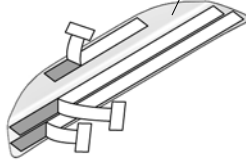

QL11207CH

11. Align the left rear cover.

<SECTION VIEW>

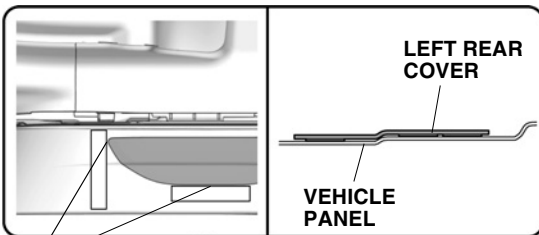

LEFT REAR COVER

VEHICLE PANEL

Align.

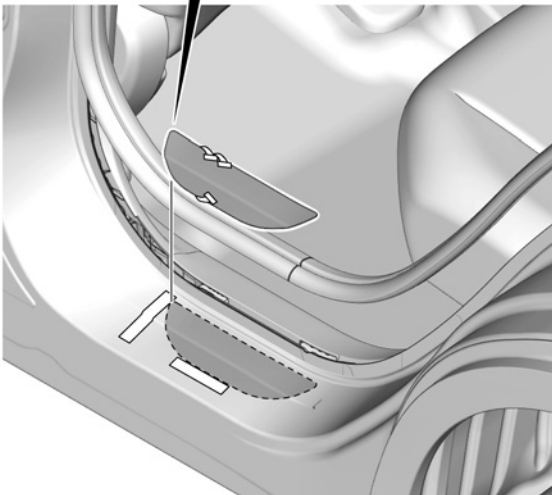

QM50207AK

12. Secure the left rear cover.

NOTICE

- Install in the order shown.
- Check the position of the double-sided adhesive tapes and make sure to press firmly.

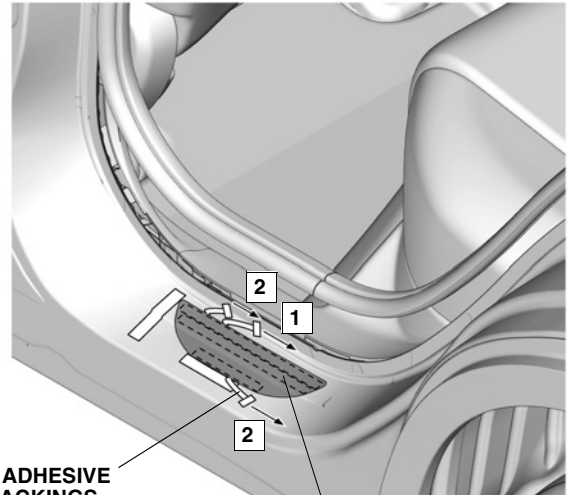

3 ADHESIVE BACKINGS

3 DOUBLE-SIDED ADHESIVE TAPES

QM50208AK



13. Remove the masking tapes.

14. Reinstall the door opening seal.

15. Repeat the same procedures on the other side.

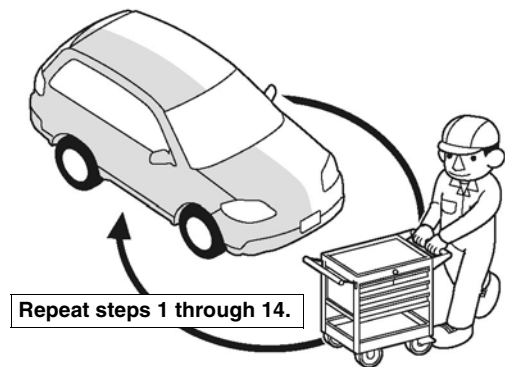

Q9D1014AM

16. Check that all parts are installed properly.
(End of installation)