

ALL SEASON MATS

e:Ny1

GENERAL VIEW

<LHD models>

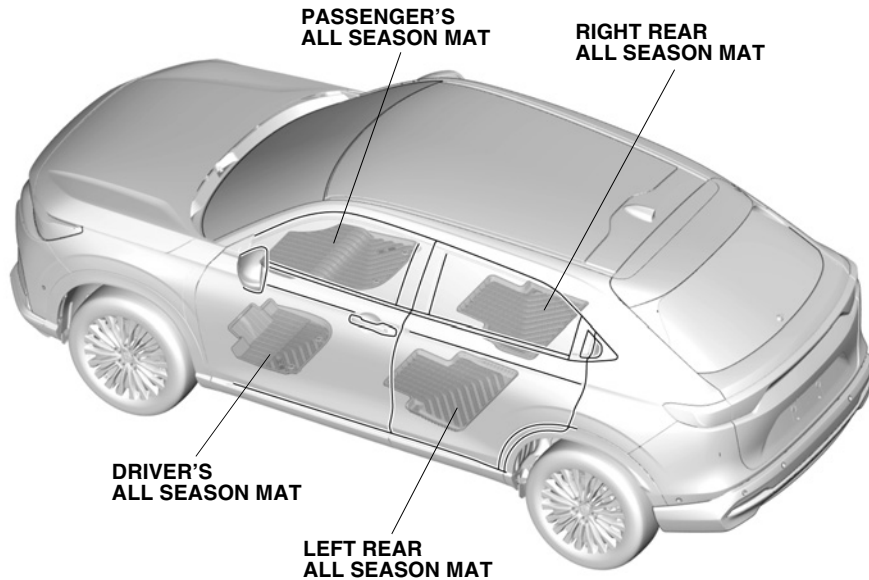

QM70501AK

<RHD models>

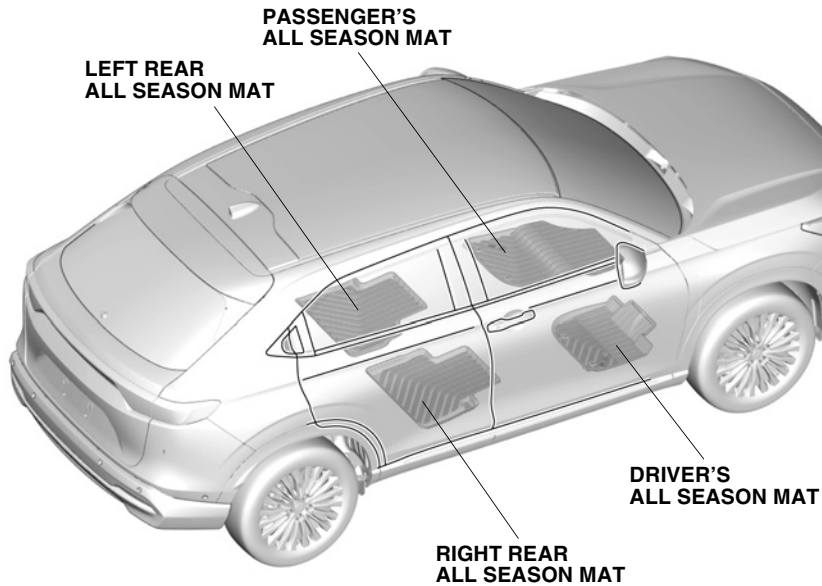

QM70507AK

FOR YOUR SAFETY (Read carefully)

Introduction of Symbol Messages

- These symbols warn you about the possible hazards and explain how to avoid them. And give you some advices.



You will be killed or seriously hurt if you do not follow the instructions.



You can be killed or seriously hurt if you do not follow the instructions.



You can be hurt if you do not follow the instructions.



Gives advice to prevent damage to the product.
Gives helpful information or instructions to be followed in using the product.



Indicates prohibited actions.

Introduction of Icons

- These icons indicate the working place and the worker's vision.

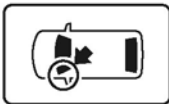

The place for the vehicle.

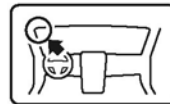

The place for the instrument panel.

- These icons indicate the necessary things for your safety and the work.



Wear eye protection.



Wear heavy gloves.



Work with an assistant.



Place the part on a blanket.



Remove any burrs.



Use the touch-up paint and dry.



Keep the parts and give it to the customer.
(Not use)



Press firmly.



Tighten by specified torque.



Work perpendicularly.



Clean with the contact cleaner.

Safety: General

- Be careful not to damage the vehicle and the parts.
- The illustrations may differ a little from the actual accessories for the design change of the vehicle.

Safety: For the Accessory

- **Before installing the all season mats, check the installation positions.**
- **Holder are required to prevent the mats from sliding forward and possibly interfering with the pedals.**
- **When replacing the all season mats, use the factory designed all season mats compatible with the holders.**
- **Do not place additional mats on top of the all season mats. The additional mats may slide forward and possibly interfere with the pedals.**
- **Make sure to re-anchor the mats after removing the all season mats.**
- **Identify each mat by the location mark on the back of each mat.**

PARTS LIST

All Season Mats Kit (LHD models)

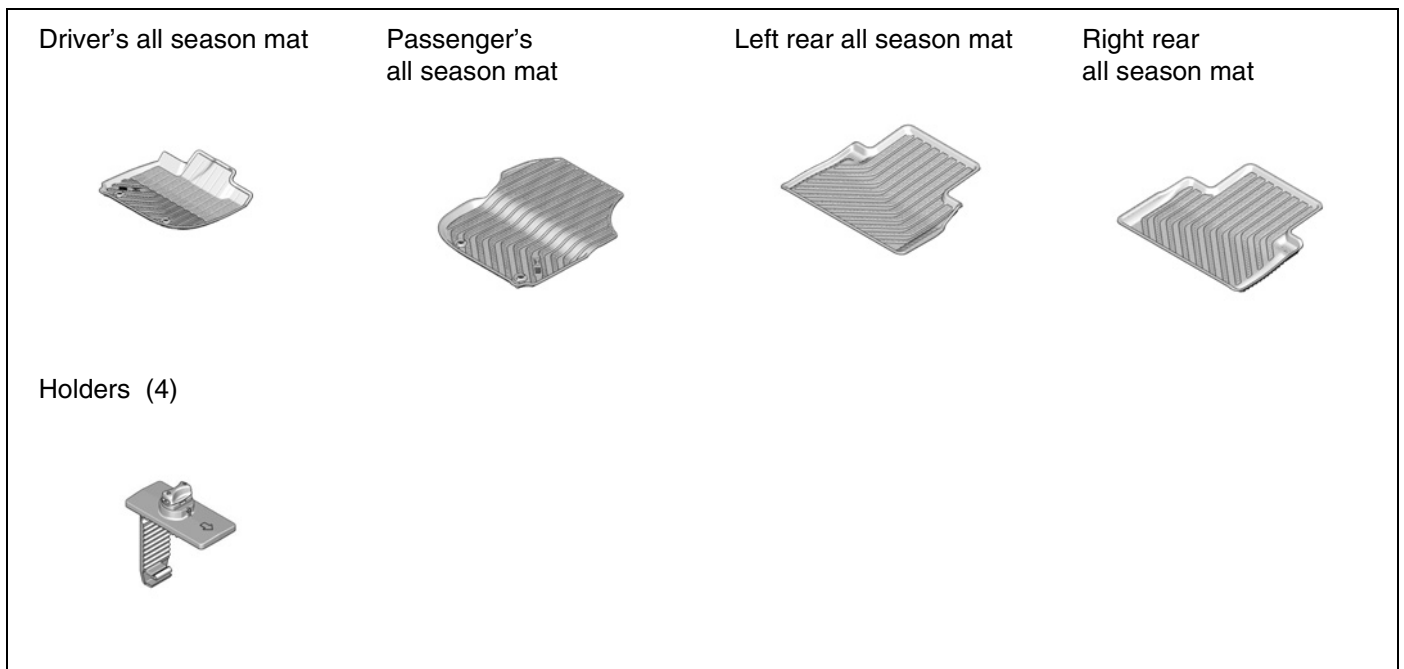

All Season Mats Kit (RHD models)

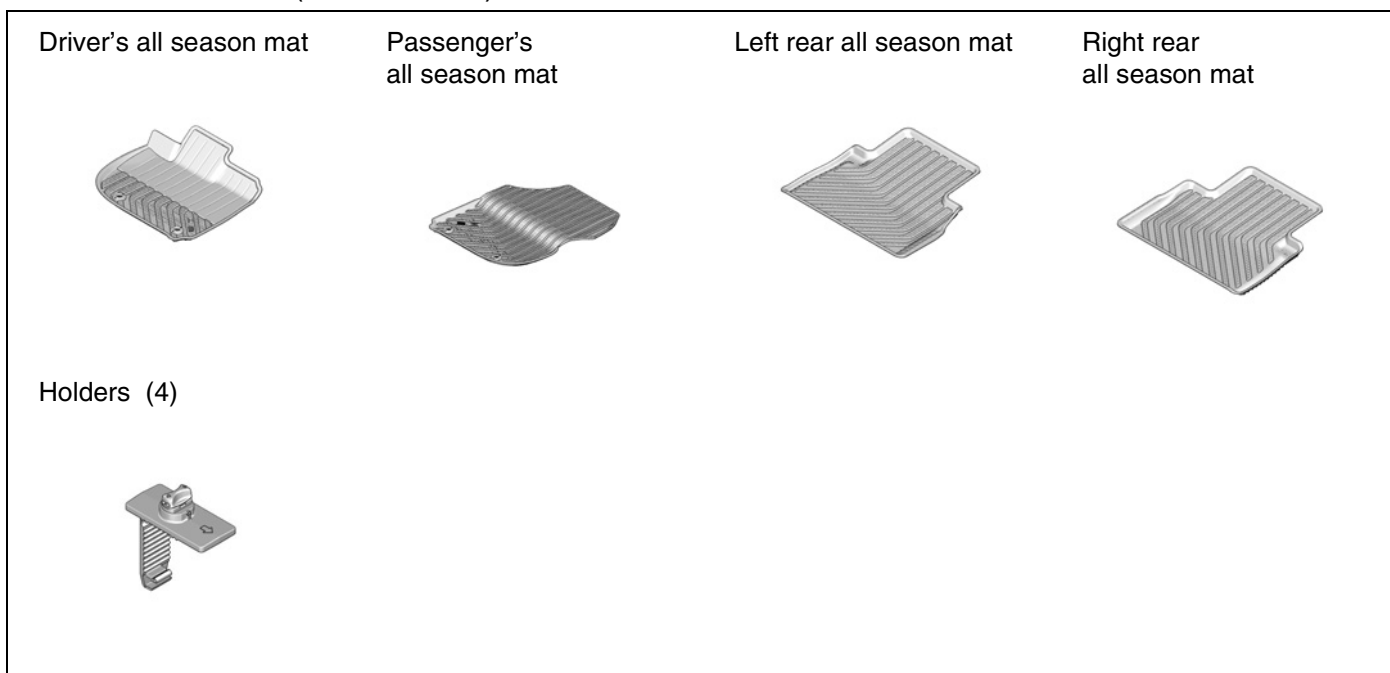

TOOLS AND SUPPLIES REQUIRED

- Flat-tip screwdriver
- Utility knife

INSTALLATION

Installing the All Season Mats

1. Follow the below guidance.

• LHD models	To step 2
• RHD models	To step 7

2. Cut out the floor carpet.

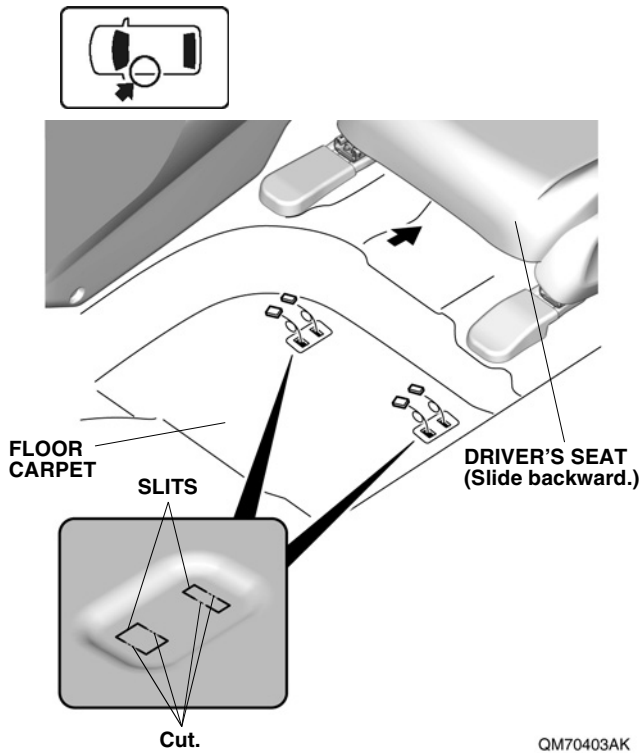

QM70403AK

3. Install the holders.

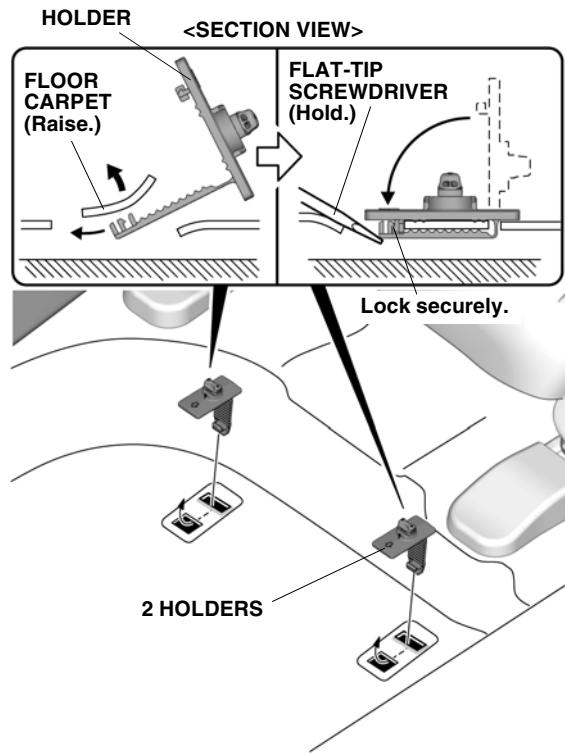

QM70404AK

4. Repeat the same procedures on the other side.

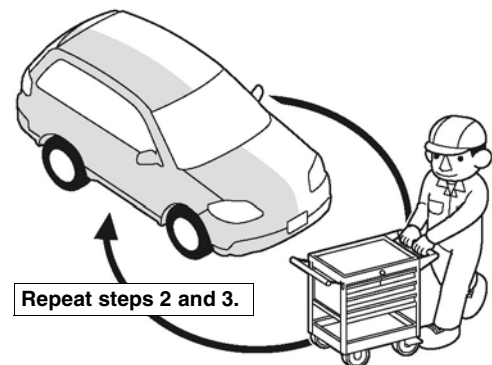

Q9D1014AM

5. Secure the driver's all season mat.

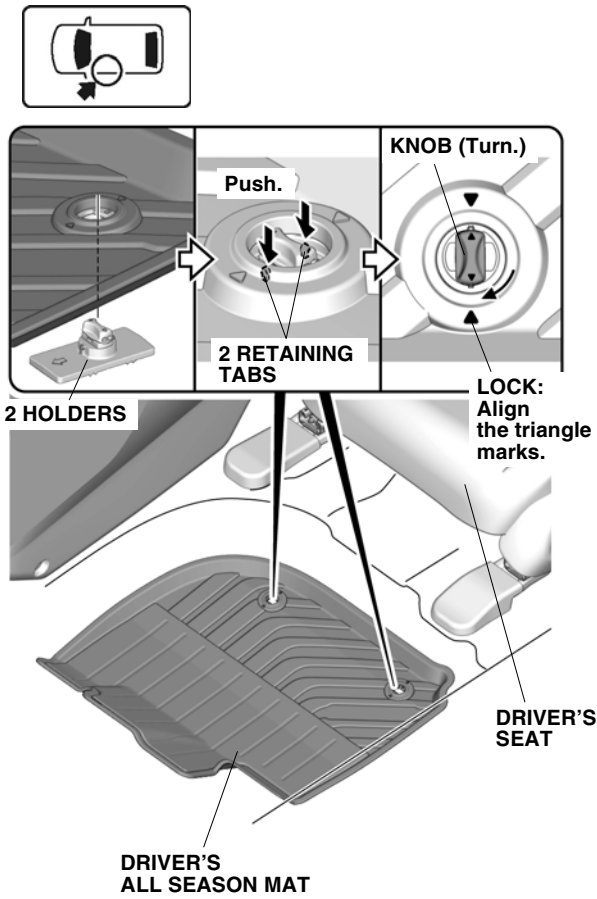

QM70502AK

6. Secure the passenger's all season mat.

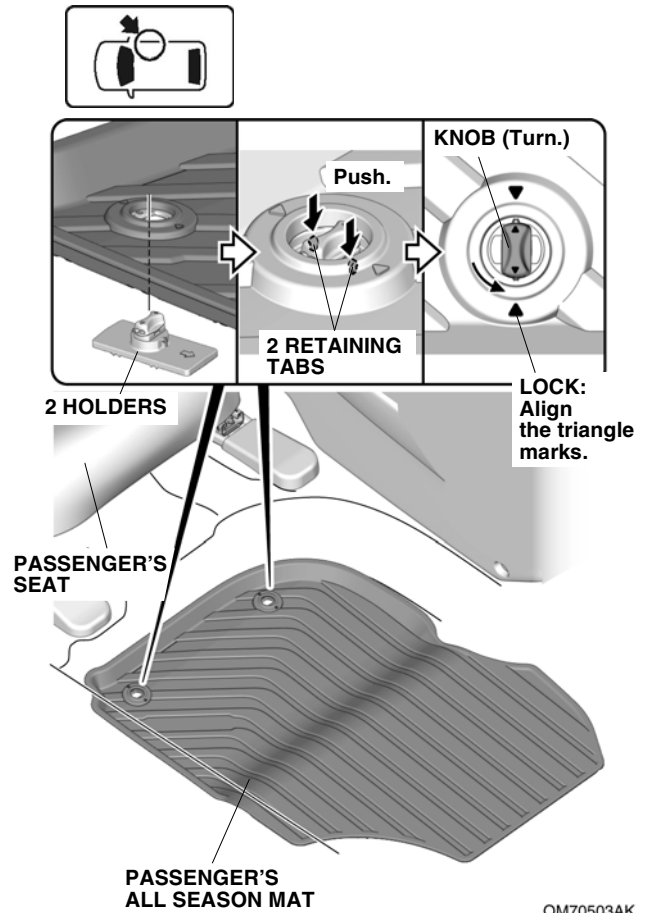

QM70503AK

To step 12

7. Cut out the floor carpet.

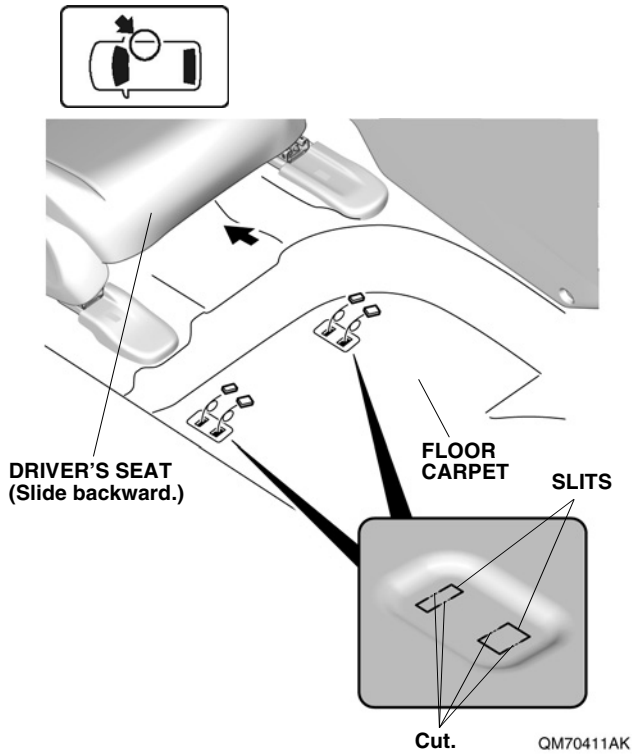

8. Install the holders.

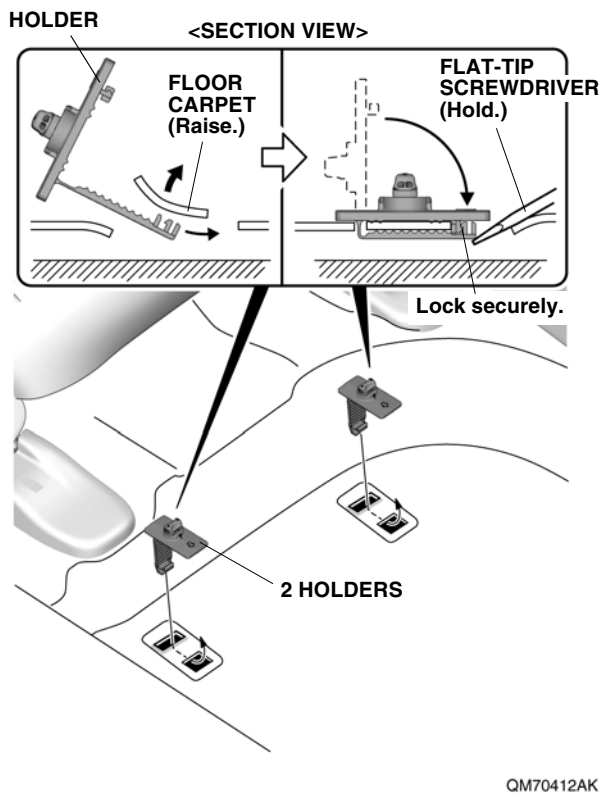

9. Repeat the same procedures on the other side.

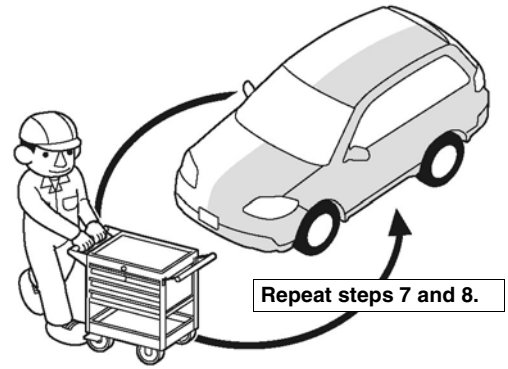

10. Secure the driver's all season mat.

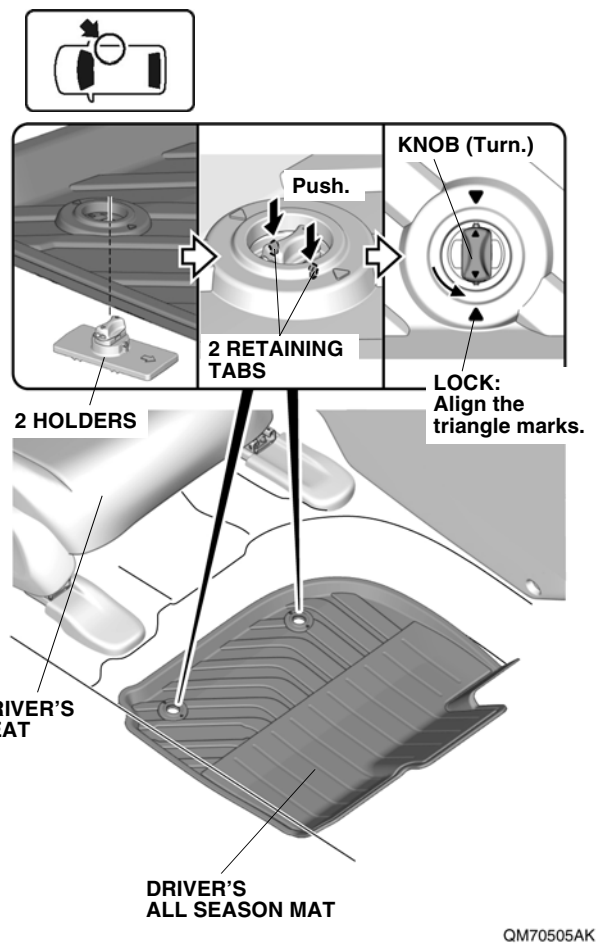

11. Secure the passenger's all season mat.

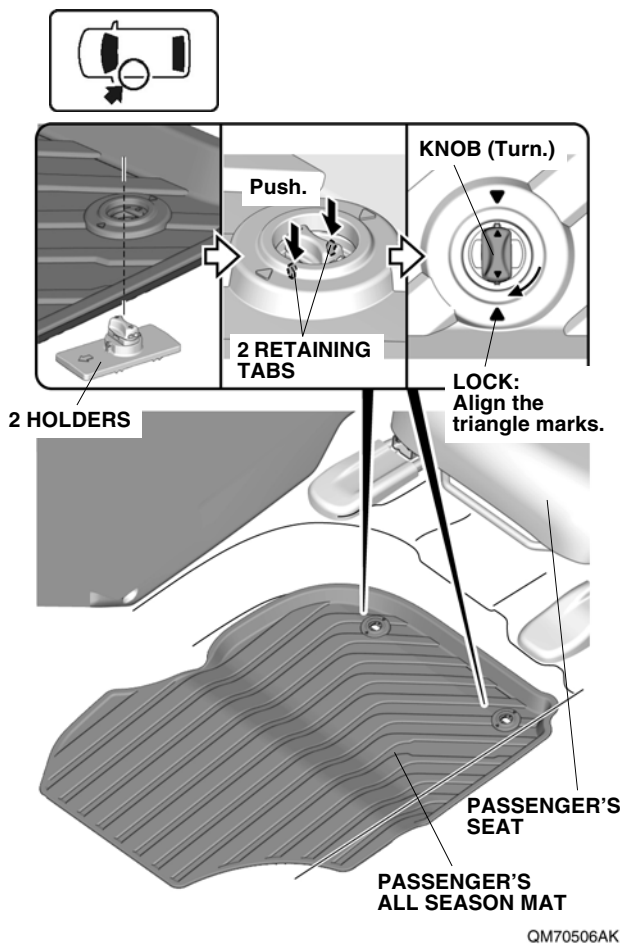

12. Install the left and right rear all season mats.

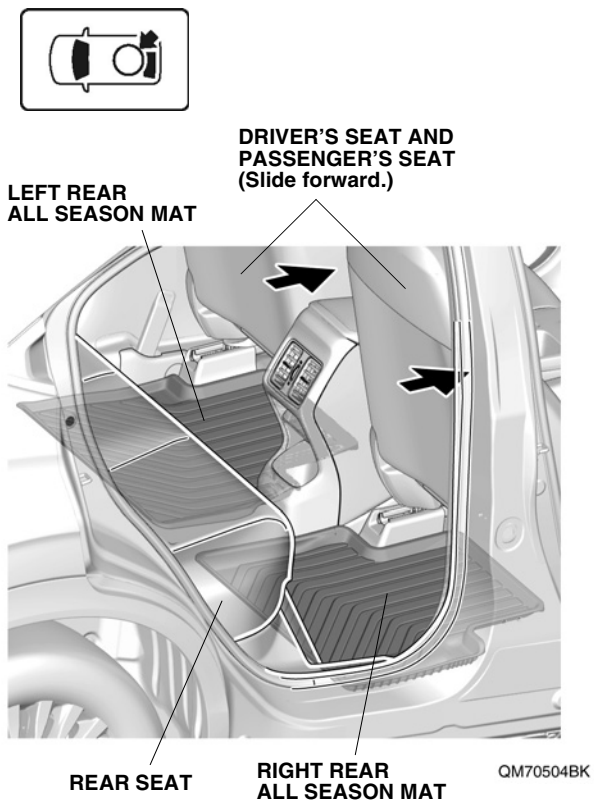

13. Check that all parts are installed properly.
(End of installation)